

# FIRST® LEGO® League 2021 Model and Pre-Pack overview

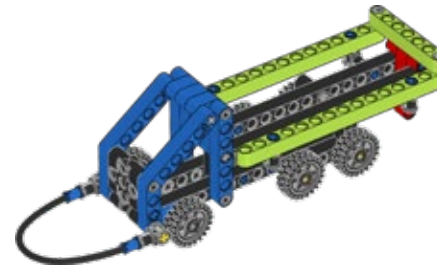

2x Platooning Trucks

45816

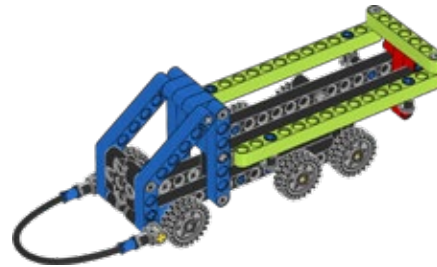
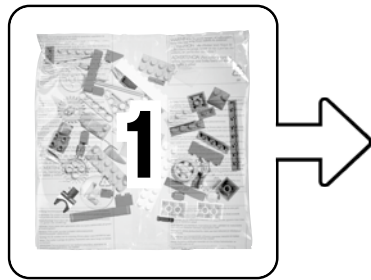

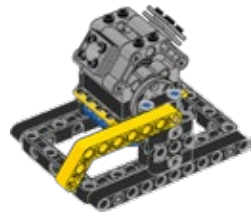
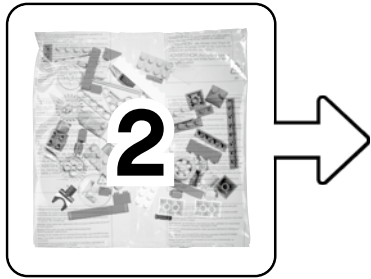

**Switch Engine**

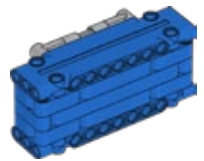
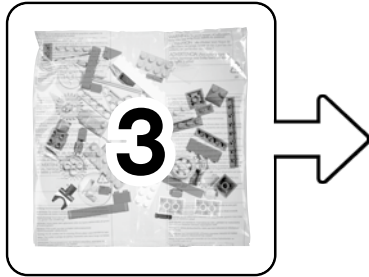

**Hinged Container**

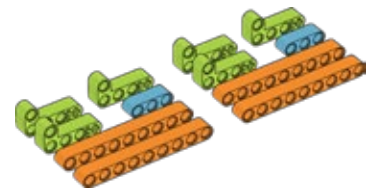

**Container Contents**



**3x Gray Containers**

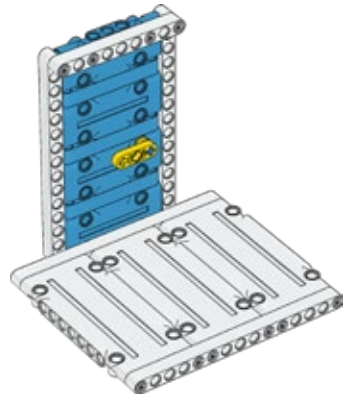
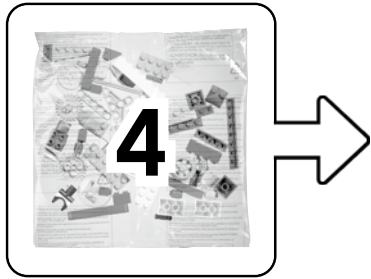

**Doorstep**



**Package**

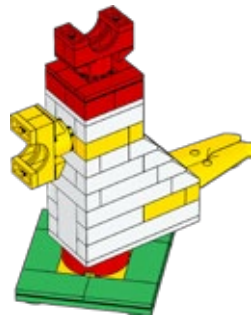
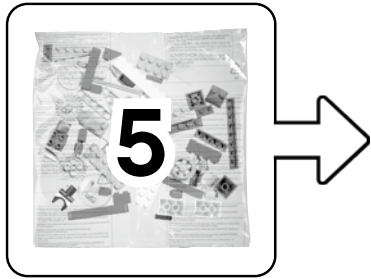

**Chicken Statue**

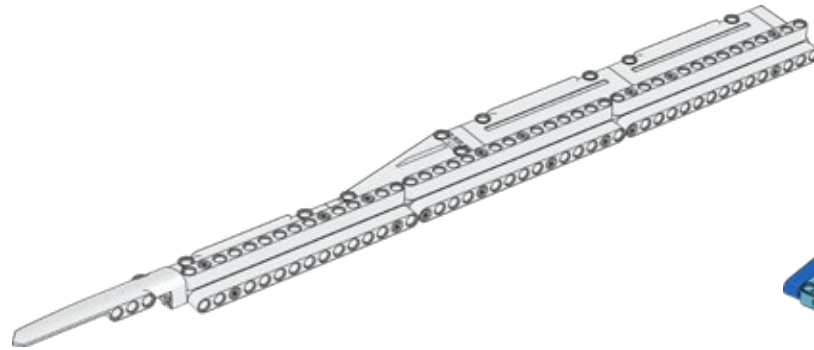
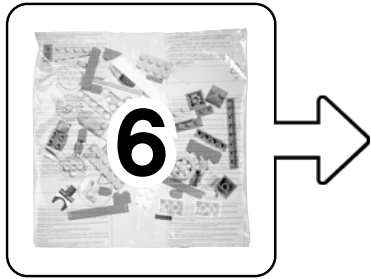

**Turbine Blade**

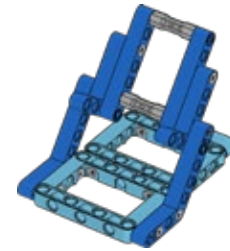

**Blue Holder**

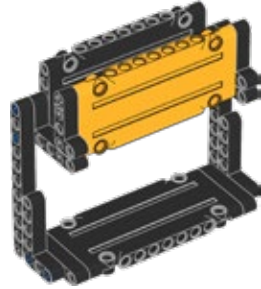
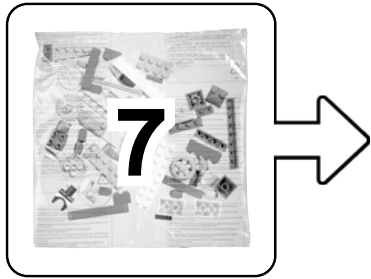

**Accident Avoidance**

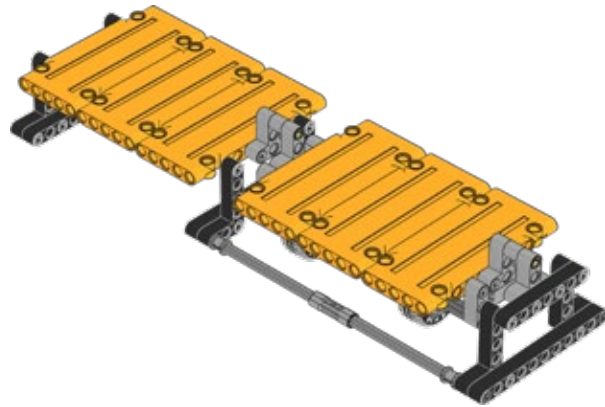
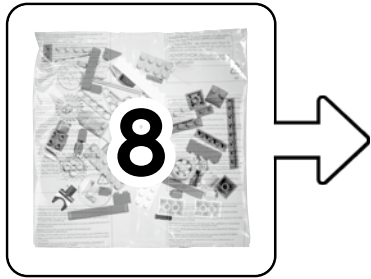

**Cargo Ship**



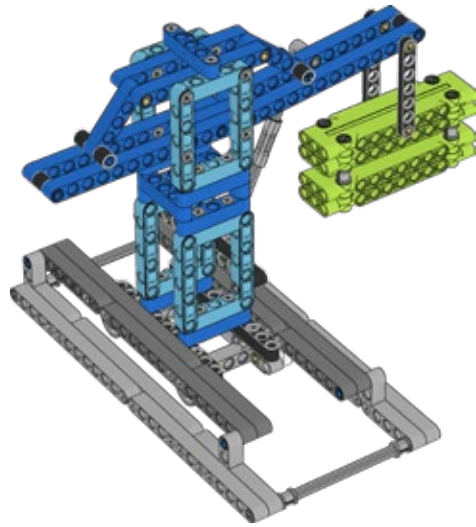
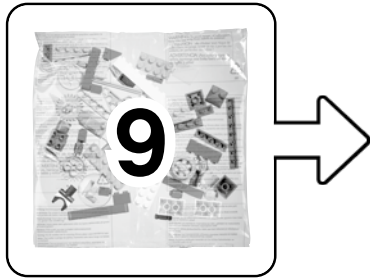

**Crane with Container**

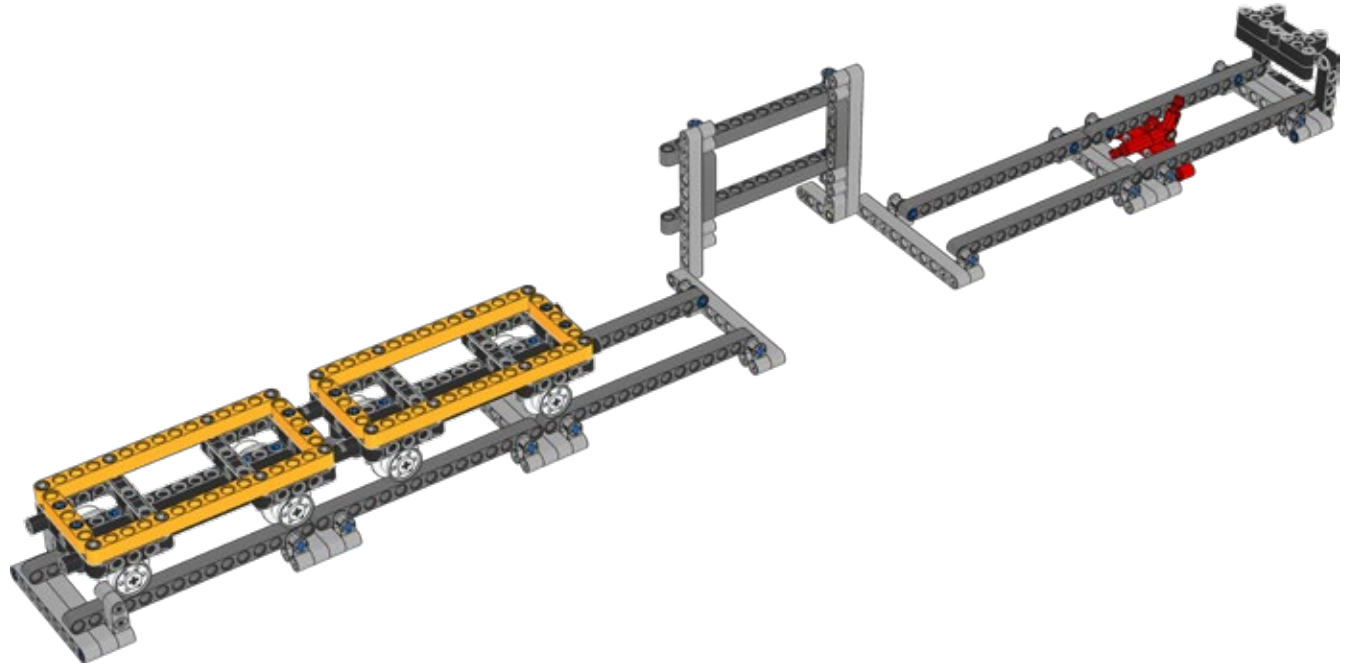
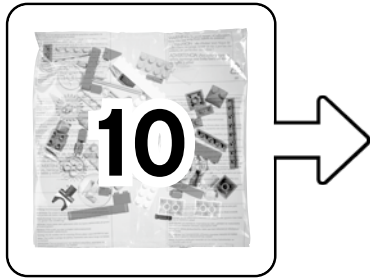

**Train Track**  
**2x Train Cars**

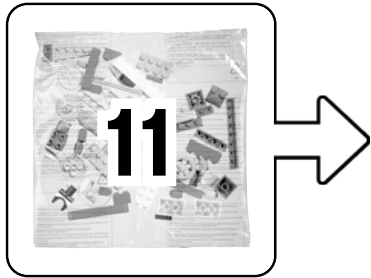

**East Bridge**



**Center Support**

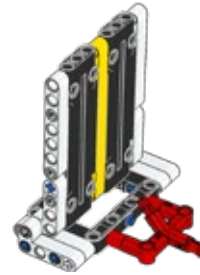

**West Bridge with Latch**

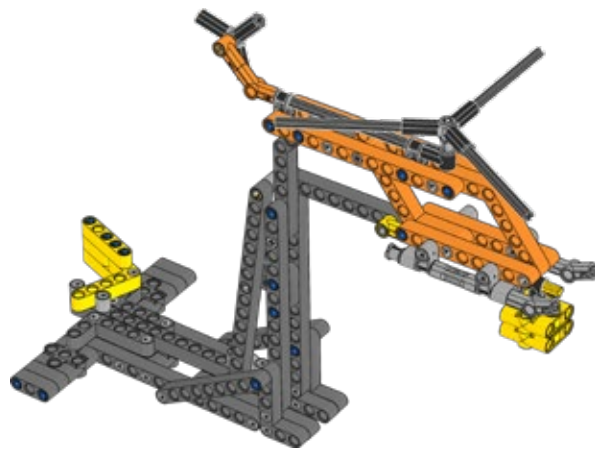
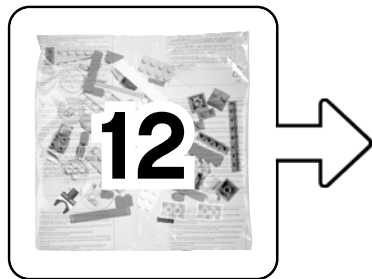

**Helicopter  
Food Package**

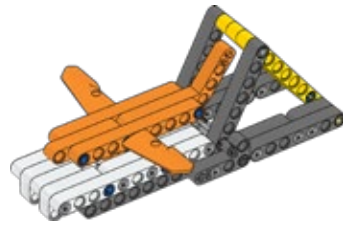
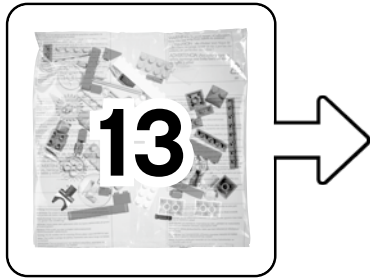

**Airplane  
Activator**

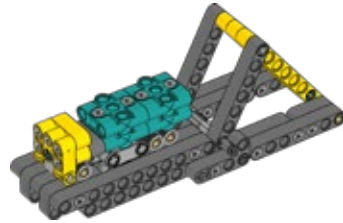

**Truck  
Activator**

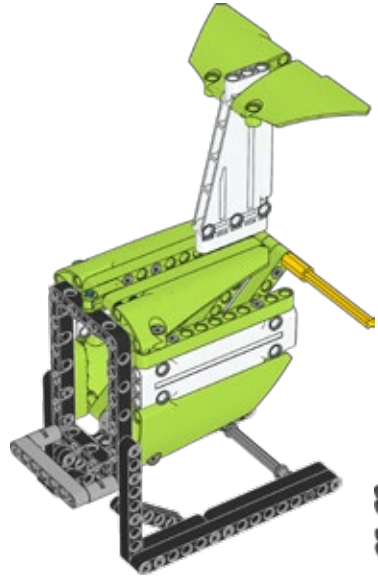
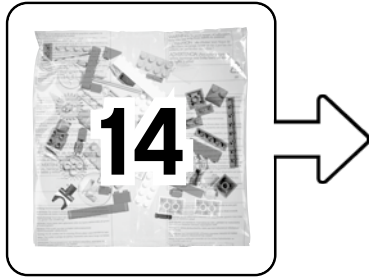

**Cargo Plane**



**1x Gray Container**

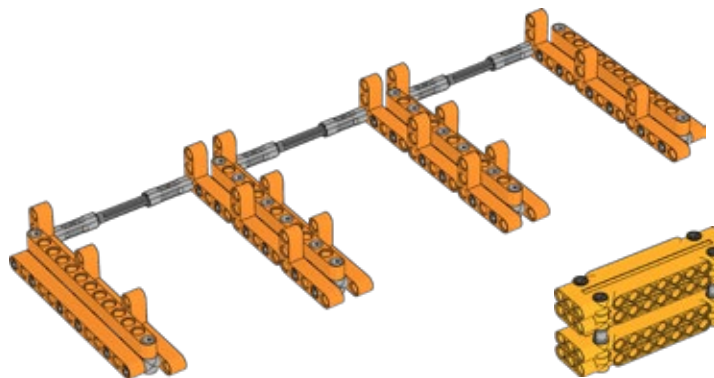
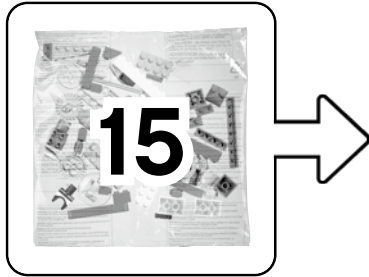

**Storage Racks**



**3x Containers  
(Light Orange, Blue, Lime Green)**

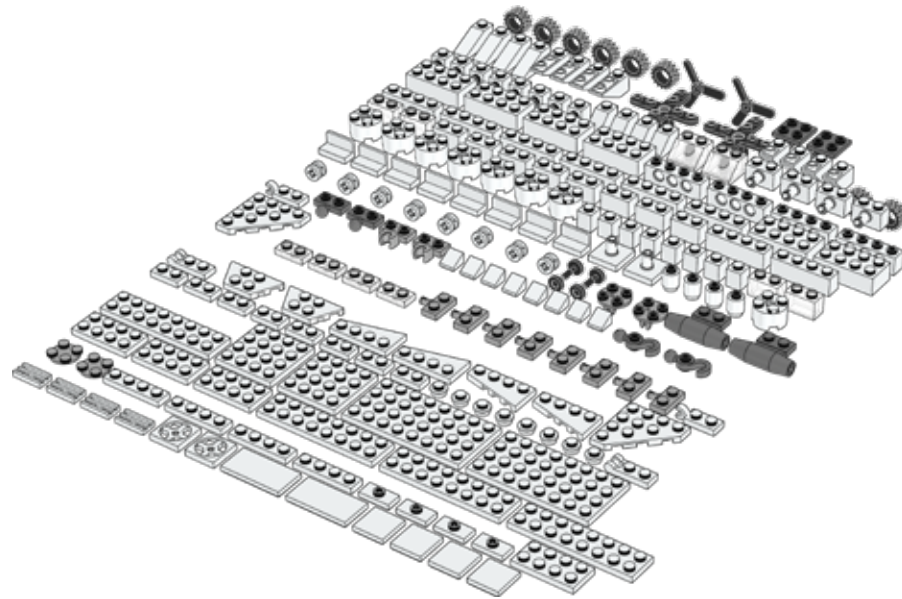
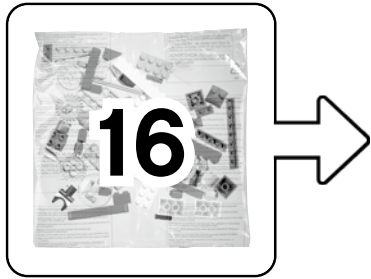

## Innovation Project Bricks



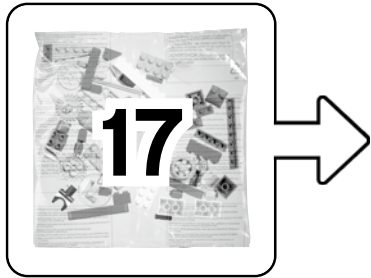

**Precision Tokens**



**Coach Pins**



**Season Tiles**

LEGO and the LEGO logo are trademarks of the/son des marques de commerce du/son marcas registradas de LEGO Group. ©2021 The LEGO Group. All rights reserved/Tous droits réservés/Todos los derechos reservados.

FIRST® is a registered trademark of For Inspiration and Recognition of Science and Technology (FIRST). LEGO® is a registered trademark of the LEGO Group. FIRST® LEGO® League and CARGO CONNECT™ are jointly held trademarks of FIRST and the LEGO Group.

©2021 FIRST and the LEGO Group. All rights reserved.