

FIRST® LEGO® League 2020 Pre-Pack overview

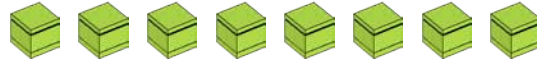

Green game cubes



Yellow game cubes



Red game cubes

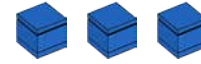

Blue game cubes

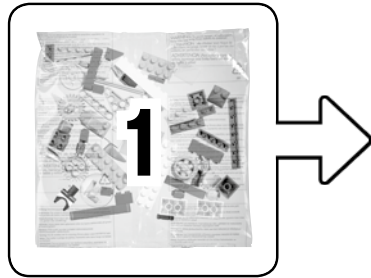

Cell phone



Health units



Coach pins



Precision tokens

45813



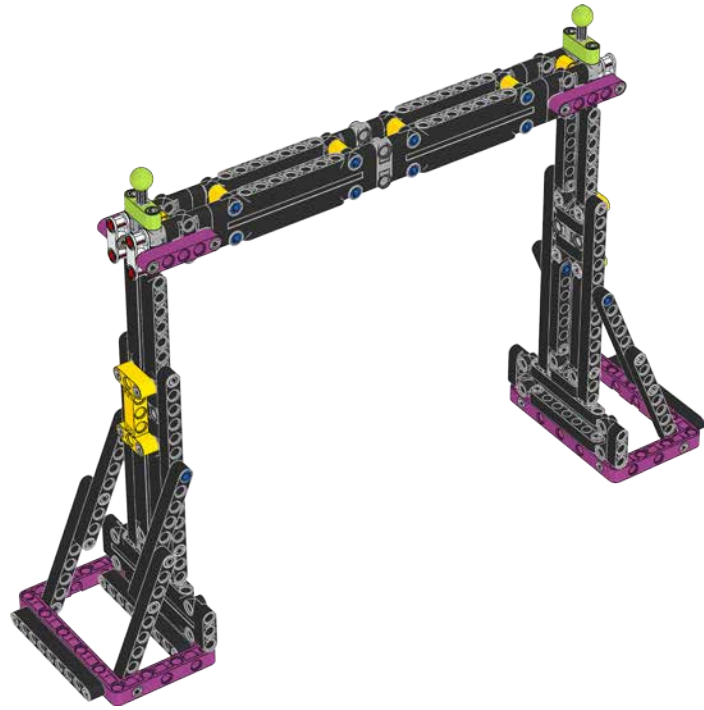
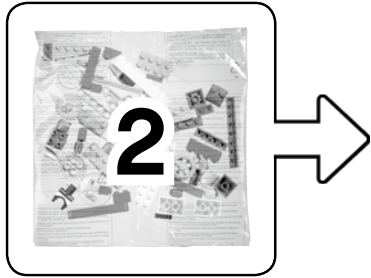

Pull-up bar

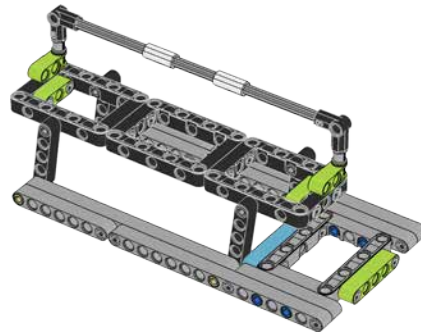
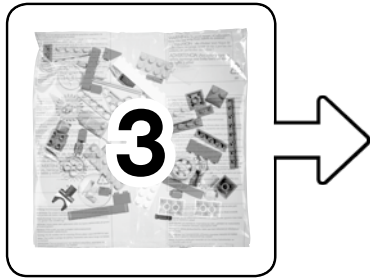

Bench

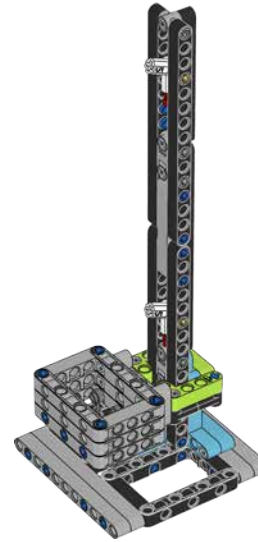

Basketball post

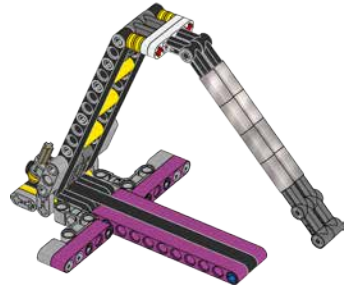
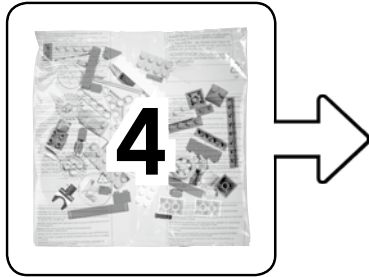

Slide

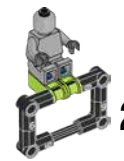

2x

Slide figures

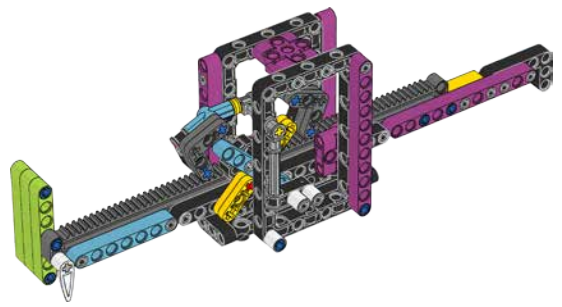

Step counter

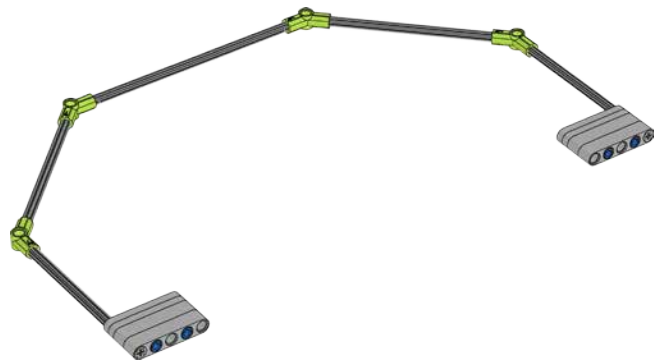
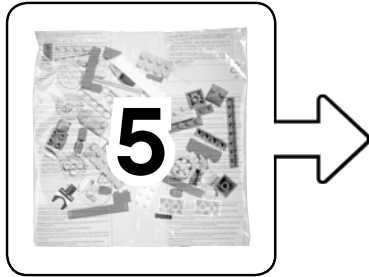

Boccia frame

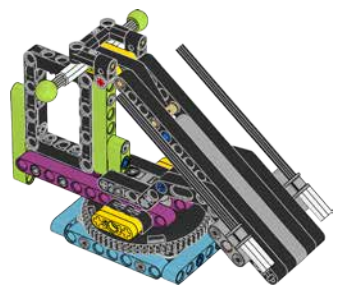

Boccia aim

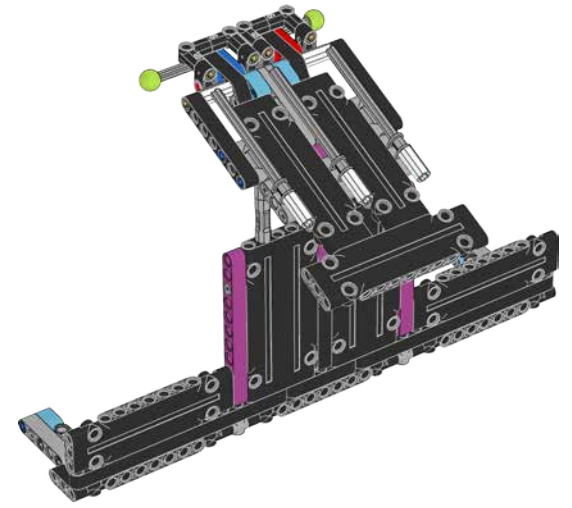

Boccia share

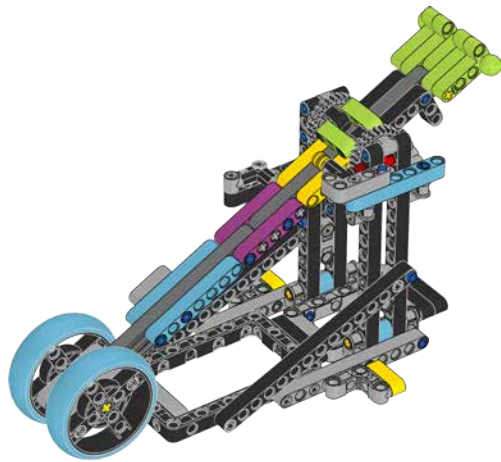
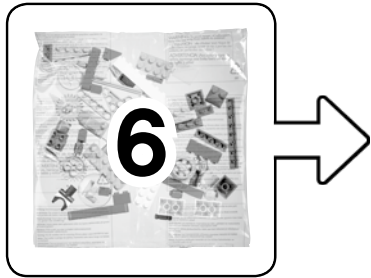

Weight machine



Rowing machine

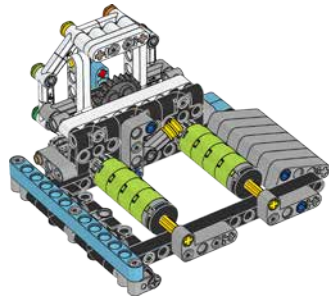
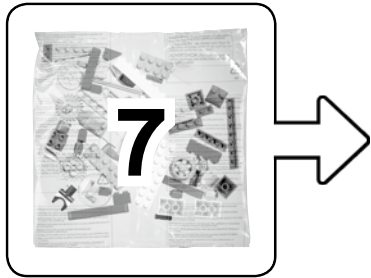

Treadmill

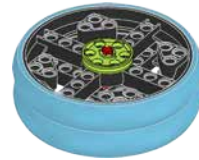

Light tire flip



Heavy tire flip

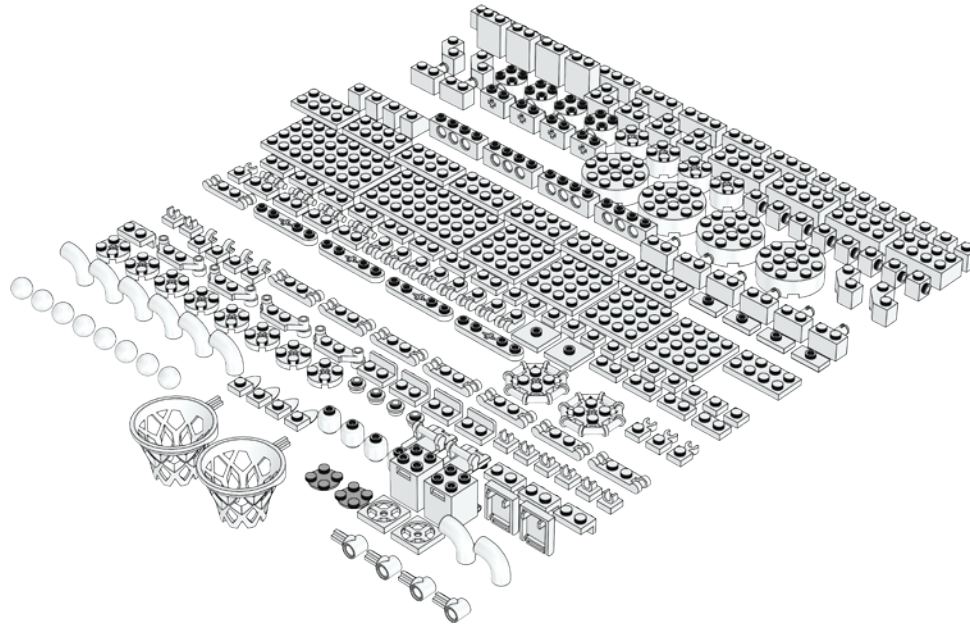
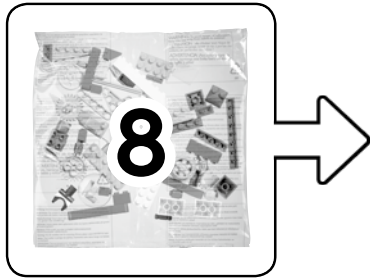

White bricks

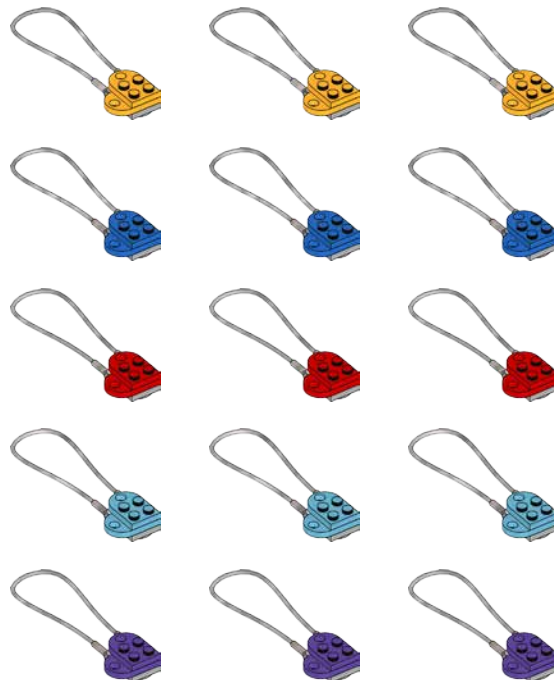
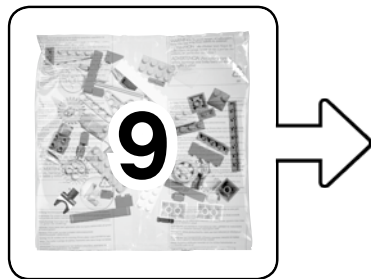

Colored health units



Season tiles

LEGO and the LEGO logo are trademarks of the/son des marques de commerce du/son marcas registradas de LEGO Group. ©2020 The LEGO Group.

FIRST® is a registered trademark of For Inspiration and Recognition of Science and Technology (FIRST). LEGO® is a registered trademark of the LEGO Group. FIRST® LEGO® League are jointly held trademarks of FIRST and the LEGO Group. ©2020 FIRST and the LEGO Group. All rights reserved.